

# TIBO - 503

500 - 300/500 W TUNGSTEN



- **Type:** Profile spot
- **Source:** 300/500 W Tungsten
- **Optics:** 30° to 45° zoom  
15° to 35° configuration possible

Profile spot

## Brighter and Smaller

The TIBO Tungsten profile presents a compact and lightweight solution in a visionary, modern design. It features an outstanding unique optical design that allows two different zoom ranges (15°-35° and 30°-45°) in one single unit. TIBO fits aesthetically into any application, from architectural to event applications as well as traditional entertainment lighting.

### Features

- **Shutter gate:** 4 shutters. Remove shutters for easy maintenance or tuck fully inside gate for secure transport
- **User-friendly shutter-lock system:** Secures shutters' setting in any circumstances
- **Universal gobo holder:** M-size, glass and metal gobos
- **Continuous 360° rotation of the fixture:** Adjustment of the projected image is always possible
- **Tilt reference on hanging yoke:** Index for rapid re-positioning

### Optical

- **Ellipsoidal reflector:** For efficient light output
- **Peak/flat adjustment:** Ergonomic button to adjust light distribution
- **Variable zoom optics:** Sharp focus at every beam angle. Independent control of image size and focus. Focus handles on both sides
- **Two different zoom ranges in one single unit:** 30/45° or 15/35° by adding/removing one lens - save on material costs and storage of separate lens tubes

### Construction

- **Made in France :** Fully manufactured on the premises retaining complete control over all aspects of quality
- **Air vents:** Efficient cooling with no light spill
- **Bodywork:** Die cast aluminium housing
- **Captive knobs and handles:** Additional security when working at height or in transit
- **Spare parts and accessories:** Uniform across the tungsten, LED or HID TIBO range, reducing running costs
- **Easy access to lens tube without tool:** Easy cleaning of zoom lenses
- **Secured lamp change without tool:** Automatic electrical disconnection of the lamp base through 2 safety switches (neutral and phase)

Picture:503

DSEN180\_503 - 04/05/2016

Robert Juliat reserves the right to change or alter any of the items detailed on this page, to increase or improve manufacturing techniques without prior notice.

**Robert Juliat S.A.S., 32 rue de Beaumont, 60530 Fresnoy-en-Thelle - France**  
Telephone : +33 (0)3 44 26 51 89 - fax : +33 (0)3 44 26 90 79 - [info@robertjuliat.fr](mailto:info@robertjuliat.fr)  
[www.robertjuliat.com](http://www.robertjuliat.com)



**ROBERT JULIAT**

## Source



- **Lamp type:** Tungsten
- **Socket:** Gy9.5

Admissible lamps	Power *	Lumen output*	Colour temperature*	Life*
LIF: CP81	300 W	7 500 lm	3200K	200 h
LIF: CP82	500 W	13 500 lm	3200K	200 h
LIF: M40	500 W	8 500 lm	2900K	2 000 h

(\*) manufacturers data

## Optics

### Characteristics

- **Type:** Zoom
- **Beam range:** 30° to 45°  
15° to 35° configuration possible
- **Focal length:** 68 - 105 mm

### Gel filter

- **Shape:** Square
- **Standard size:** 138x138 mm (5.4x5.4 in)

### Gobo

- **Size:** M
- **Material:** Metal  
Glass

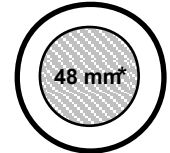

66 mm

\*Maximum image size

## Photometrics

with LIF: CP82 source

### • Optics @ 30°

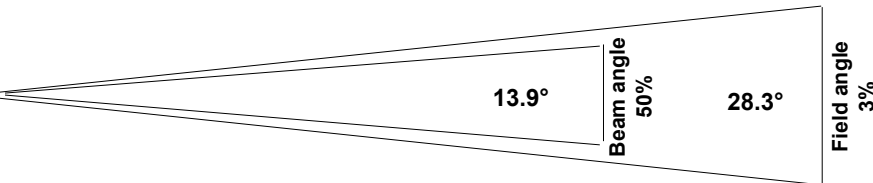
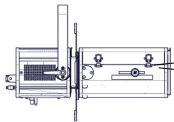

**Beam intensity**  
93 900 cd

**Field lumens**  
5 760 lm

**Efficacy**  
12 lm/W

**CCT**  
3 150 K

<b>Distance</b>	3 m	5 m	7 m	10 m	12 m	15 m
<b>Diameter</b>	1.5 m	2.5 m	3.5 m	5 m	6.1 m	7.6 m
<b>Illumination</b>	10 500 lux	3 800 lux	1 950 lux	940 lux	660 lux	420 lux
<b>Distance</b>	10 ft	15 ft	25 ft	35 ft	40 ft	50 ft
<b>Diameter</b>	5 ft	7.6 ft	12.6 ft	17.6 ft	20.2 ft	25.2 ft
<b>Illumination</b>	940 fc	420 fc	160 fc	80 fc	60 fc	38 fc

### • Optics @ 45°

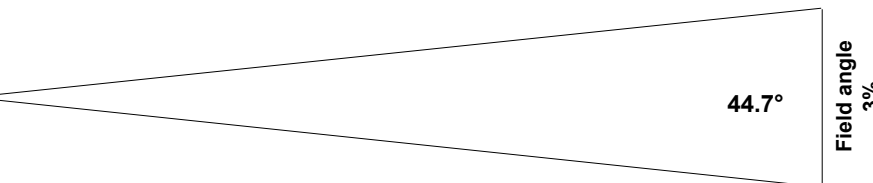
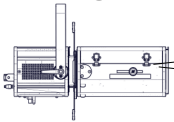

**Beam intensity**  
63 300 cd

**CCT**  
3 130 K

<b>Distance</b>	3 m	5 m	7 m	10 m	12 m	15 m
<b>Diameter</b>	2.5 m	4.1 m	5.8 m	8.2 m	9.9 m	12.3 m
<b>Illumination</b>	7 100 lux	2 550 lux	1 300 lux	640 lux	440 lux	290 lux
<b>Distance</b>	10 ft	15 ft	25 ft	35 ft	40 ft	50 ft
<b>Diameter</b>	8.2 ft	12.3 ft	20.6 ft	28.8 ft	32.9 ft	41.1 ft
<b>Illumination</b>	640 fc	290 fc	110 fc	55 fc	40 fc	26 fc

## Dimensions and weight

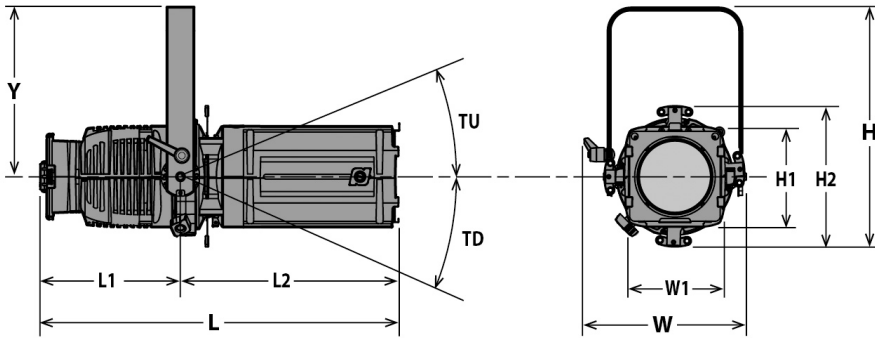

**Weight:** 6.9 kg (15.2 lbs)

Height	Length	Width	Yoke	Tilt
H= 363 mm (14.3 in)	L= 536 mm (21.1 in)	W= 251 mm (9.9 in)	Y= 252 mm (9.9 in)	TU= 67°
H1= 150 mm (5.9 in)	L1= 210 mm (8.3 in)	W1= 150 mm (5.9 in)		TD= 90°
H2= 226 mm (8.9 in)	L2= 326 mm (12.8 in)			

## Shipping

- **Weight :** 8.5 kg (18.7 lbs)
- **Volume :** .04 m<sup>3</sup> (1.38 ft<sup>3</sup>)

## Installation

- **Minimum distance to illuminated surface:** 1.8 m ( 5.9 ft )
- **Operating position:**

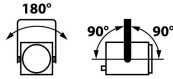

## Construction

- **Housing:** Die cast aluminium
- **Colour:** Black
- **Cooling:** Convection cooling
- **Maximum ambient temperature (Ta):** 40°C (104°F)
- **Maximum case temperature (Tc) :** 170°C (338°F)
- **Total heat dissipation:** 1 024 BTU/h
- **Protection rating:** 20

## Electrical compatibility

- 230/240 V - 50 Hz
- 115/120 V - 60 Hz

## Power input



- **Type:** attached power cord
- **Cable:** HT Silicon 3G1
- **Length:** 1,5 m (4,9 ft)
- **Power connector:** without connector

## Power consumption

Voltage	Frequency	Current	Power
230 V	50 Hz	1.3 A	300 W
230 V	50 Hz	2.2 A	500 W

## Approvals

## Warranty

- **Period: 2 years**  
See General Sales Condition on website









## Model

<b>503</b>	300/500 W Tungsten Profile spot - Gy9.5 socket - 503 Tibo - 30/45°
------------	--

## Options

<b>PCP1716A</b>	16A blue 2P+E 6h IEC60309 power connector	
-----------------	---	---

## Accessories

<b>D4</b>	Shutter for Tibo series <b>4 included</b>	
<b>PF100M</b>	135x135mm metal filter holder <b>1 included</b>	
<b>CP82</b>	CP82 - Gy9.5 500W 230V 200h 3200K lamp	
<b>IS500</b>	Drop-in iris (monoplane) with holder	
<b>SGUT</b>	Universal "M" size gobo-holder (metal, glass, frosted glass)	
<b>872</b>	Doughty "Twenty clamp" with M10 screw/nut for Ø48 to 51mm pipes - SWL: 20Kg - TÜV approved - Weight: ,25 Kg	
<b>878</b>	Hook clamp 25x6mm with 23mm M10 screw for Ø35 to 50mm pipes - SWL: 11Kg - Weight: ,46 Kg	
<b>CS2</b>	Safety cable Ø3 mm L= 600mm - SWL: 75 Kg	