

Studio Due



CitybeamLED²⁴
RGBW • full color

CitybeamLED¹²
RGBW • full color

User manual for art. 1303 and 1304
Manuale d'uso per art. 1303 e 1304

4 PIN connector - Connettore 4 PIN



In this connector you can find the NUMBER 4 or the GROUND sign.

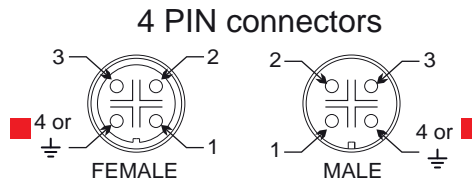

PIN	SIGNAL
1	GROUND/RETURN/OV
2	N.C.
3	DATA COMPLEMENT (-, INVERTED)
4 or \perp	DATA TRUE (+, NON INVERTED)



WARNING
IMPORTANTE

In questo connettore potete trovare il NUMERO 4 o il simbolo della TERRA.

IMPORTANTE **WARNING**

endowed with the fixture - incluso nell'apparecchio

If you want to connect the fixtures for **OUTDOOR** use, you can make a new cable utilizing the **art. 4 PIN-CONN M/F**

The cable is not endowed with the connectors kit

art. 4 PIN-CONN M/F



Se volete utilizzare gli apparecchi all'**ESTERNO**, potete realizzare dei nuovi cavi con **art. 4 PIN-CONN M/F**

Il cavo non è incluso nel kit dei connettori

optional - opzionale



art. 4 PIN/XLR MF (OPTIONAL)

these CONNECTORS are for INDOOR use only

questi connettori sono solo per uso INTERNO

INDOOR USE ONLY

art. 4 PIN/XLR MF male/female connectors (optional)

art. 4 PIN/XLR MF connettori maschio/femmina (opzionale)

these CONNECTORS are IP67

questi connettori sono IP67

INDEX

Page 4 - Safety informations / Informazioni di sicurezza

Page 5 - Introduction / Introduzione

Page 6 - Technical features / Caratteristiche tecniche

Page 7 - Example of connection DMX controller-fixtures / Esempio di collegamento centralina DMX-fari

Page 7 - DMX signal connection / Collegamento segnale DMX

Page 8 - Main supply connection / Collegamento fonte di alimentazione

Page 9 - Rear view fixture connections / Vista posteriore connessioni apparecchio

Page 10 - Control panel functions / Funzioni del pannello di controllo

Page 15 - DMX Listing / Lista dei canali DMX

Page 17 - Built in programs / Lista dei giochi

Page 18 - Physical / Dimensioni

Page 20 - CE standards / Certificazioni CE

Page 22 - Warranty / Garanzia



• Art. 1304 CityBeam LED 24 RGBW/FC (full color)



• Art. 1303 CityBeam LED 12 RGBW/FC (full color)



**WARNING****SAFETY INFORMATION (service personnel)**

READ ALL CAUTIONS AND WARNINGS PRIOR TO OPERATE THIS EQUIPMENT.
INSTRUCTION TO PREVENT INJURY OR DAMAGE DUE TO ELECTRIC SHOCK, FIRE, MECHANICAL HAZARDS,
DANGEROUS MATTERS.

•PROTECTION AGAINST DANGEROUS MATTERS

At the end of its life, must be collected separately. It shouldn't be thrown as urban waste and neither released in the environment.

It must be collected from the nearest special waste collection point or consigned to your dealer that provides the service. The incorrect waste disposal can damage the environment and the people for the presence of dangerous substances. Sanctions are provided for an unauthorized disposal.

**•PROTECTION AGAINST FIRE**

- 1) Maintain minimum distance of 0.2 meter from walls or any other type flammable surfaces.
- 2) Maintain minimum distance of 0,2 meter to lighted objects .
- 3) Replace fuses (if present) only with the specified type and rating.
- 4) Do not install the fixture close to heat sources. Do not lay the connection cable on the fixture when it is warm.
- 5) Fixture designed to be installed on normally flammable surfaces.

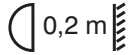
**•PROTECTION AGAINST ELECTRIC SHOCK**

- 1) **This equipment must be earthed.**
- 2) Class I equipment. The power supply cord includes a protective earthing conductor as part of the cord.
- 3) Disconnect power before servicing (service personnel).

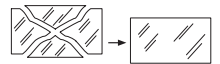
**•PROTECTION AGAINST MECHANICAL HAZARDS**

- 1) Use secondary safety chain when fixing this equipment.
- 2) Equipment surface may reach temperature up to 75°C.
- 3) The protection screens and the lenses must be replaced with genuine parts only if they are visibly damaged and their effectiveness has been reduced, for example, by cracks or deep scratches.

**IMPORTANTE****INFORMAZIONI DI SICUREZZA (personale di servizio)**

LEGGERE ATTENTAMENTE TUTTI GLI AVVERTIMENTI PRIMA DI COMPIERE QUALUNQUE OPERAZIONE SU QUESTO APPARECCHIO. ISTRUZIONI PER PREVENIRE LESIONI O DANNI DOVUTI AL FUOCO, ALLE SCOSSE ELETTRICHE, AI RISCHI MECCANICI ED A SOSTANZE PERICOLOSE.

•PROTEZIONE CONTRO SOSTANZE PERICOLOSE

A fine vita è oggetto di raccolta separata, non gettare nei comuni cassonetti di rifiuti urbani, né tantomeno nell'ambiente. Può essere consegnato presso gli appositi centri di raccolta differenziata predisposti dalle amministrazioni comunali, oppure presso i rivenditori che forniscono questo servizio. Lo smaltimento errato può causare danni alle persone e all'ambiente per la possibile presenza di sostanze pericolose. Sono previste sanzioni in caso di smaltimento abusivo dei suddetti prodotti.

**•PROTEZIONE CONTRO IL FUOCO**

- 1) Mantenere la distanza minima di 0.2 metri da pareti ed altre superfici infiammabili.
- 2) Mantenere la distanza minima di 0,2 metri dagli oggetti illuminati.
- 3) Sostituire i fusibili (se presenti) solo con altri dello stesso tipo e valore.
- 4) Non installare il faro vicino fonti di calore. Non appoggiare il cavo di connessione sul faro quando questo è caldo.
- 5) Questo apparecchio è adatto per il montaggio su superfici normalmente infiammabili.

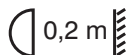
**•PROTEZIONE CONTRO SCOSSE ELETTRICHE**

- 1) **Questo apparecchio necessita di messa a terra.**
- 2) Apparecchio di Classe I. Il conduttore di protezione deve far parte del cavo di alimentazione.
- 3) Disconnettere l'alimentazione prima di aprire l'apparecchio (personale di servizio).

**•PROTEZIONE CONTRO RISCHI MECCANICI**

- 1) Usare la catena di sicurezza supplementare quando installate il faro.
- 2) La temperatura dell'apparecchio può raggiungere 75°C.
- 3) Gli schermi di protezione e le lenti devono essere sostituiti sempre con ricambi originali se sono visibilmente danneggiati e se la loro efficacia è stata ridotta, per esempio, da fessure o incisioni profonde.



INTRODUCTION

Thanks for using CityBeam LED RGBW/FC.

The CityBeam LED is a new IP67, RGBW Full Color long distance outdoor colour changer.

To reach impressive heights, no matter how complex it is, the new CityBeam LED line is the right solution.

Whatever is the final application, where long distance light output is required the CityBeam LED family solve your problem.

- **Art. 1303 CityBeam LED 12 RGBW/FC (full color)**
- **Art. 1304 CityBeam LED 24 RGBW/FC (full color)**

To obtain the best performances and for a correct functioning of this unit for the years to come, we suggest you to read carefully this manual before connecting or putting the fixture into use. By doing so you will gain experience with its commands and connections and you will be easily able to use it.

YOUR REFERENCE

Always remember to give the serial number and to specify the model any time you address the seller for information or assistance.

BASIC KIT

- Projector
- 2 connectors 4 pin male and female (without cable)
- User manual
- Studio Due warranty
- CE standards

**WARNING**

Check that the fixture has not been damaged during transport. If it has been damaged or it does not work, address the seller. Whether the fixture has been shipped to you directly, please contact the shipping company. Only the consignee (person or company) can claim for these damages.

INTRODUZIONE

Vi ringraziamo per l' utilizzo del nostro CityBeam LED RGBW/FC.

Il CityBeam LED è un nuovo apparecchio cambiacolori IP67 RGBW Full Color.

Qualunque sia l'applicazione finale, dove è richiesta potenza luminosa a lunga distanza, la famiglia LED CITYBEAM risolvere egregiamente il problema.

- **Art. 1303 CityBeam LED 12 RGBW/FC (full color)**
- **Art. 1304 CityBeam LED 24 RGBW/FC (full color)**

Per ottenere il meglio delle prestazioni ed un corretto funzionamento negli anni di questa unità, Vi consigliamo di leggere attentamente questo manuale prima di collegarla e metterla in uso. In questo modo acquisirete familiarità con i suoi comandi e collegamenti affinché possiate utilizzarla facilmente.

VOSTRA REFERENZA

Citate sempre il numero del modello e di serie ogni volta che Vi rivolgete al vostro rivenditore per informazioni o assistenza.

CONFEZIONE BASE

- Proiettore
- 2 connettori a 4 pin maschio e femmina (senza cavo)
- Manuale d'uso
- Garanzia Studio Due
- Dichiarazione CE

**IMPORTANTE**

Controllate che l'apparecchio non abbia subito alcun danno durante il trasporto.

Se avesse subito dei danni o se non dovesse funzionare, rivolgetevi al vostro rivenditore.

Se l'apparecchio vi è stato spedito direttamente, rivolgetevi subito alla ditta di trasporto.

Solo il destinatario (la persona o ditta ricevente l'apparecchio) può reclamare per questo tipo di danni.

CITYBEAM LED 24



- **SOURCE**
n. 24 RGBW (20W) LEDs
190W total LEDs power
- **OPTIC**
6° (45 mm lenses)
- **TILT**
Manual 160°
- **CONTROL**
Standard interface: RS-485, optocoupled input
Protocol: USITT DMX512
- **CONNECTIONS**
Signal: 4pin IP 67 connector (male-female)
Main Power: 3x1mm cable
Available as accessories:
- Wireless DMX receiver
- **SAFETY**
n. 2 eyebolts for safety chains
- **SETUP AND CONFIGURATION**
Control panel with touch technology
Led display with flip function
Dedicated DMX channel for white balance
DMX or Auto mode with Master-Slave function
Intelligent temperature control
Flicker-free function
Smooth dimming function
Halogen simulation
CYM simulation
- **RATING PROTECTION**
IP 67
- **DMX CHANNELS**
- 9CH mode
- 5CH mode
- 4CH mode
- **POWER SUPPLY**
320W switching power supply
Rated voltage 100-240V~
Frequency 50-60Hz
Rated current 1.1A@230V-Fuse T5A
Active PFC
Power consumption 210W (all color full power)
- **PHYSICAL**
WxDxH: 615x180x420 mm
Weight: 18,5 Kg.

CITYBEAM LED 12



- **SOURCE**
n. 12 RGBW (20W) LEDs
95W total LEDs power
- **OPTIC**
6° (45 mm lenses)
- **TILT**
Manual 160°
- **CONTROL**
Standard interface: RS-485, optocoupled input
Protocol: USITT DMX512
- **CONNECTIONS**
Signal: 4pin IP 67 connector (male-female)
Main Power: 3x1mm cable
Available as accessories:
- Wireless DMX receiver
- **SAFETY**
n. 2 eyebolts for safety chains
- **SETUP AND CONFIGURATION**
Control panel with touch technology
Led display with flip function
Dedicated DMX channel for white balance
DMX or Auto mode with Master-Slave function
Intelligent temperature control
Flicker-free function
Smooth dimming function
Halogen simulation
CYM simulation
- **RATING PROTECTION**
IP 67
- **DMX CHANNELS**
- 9CH mode
- 5CH mode
- 4CH mode
- **POWER SUPPLY**
320W switching power supply
Rated voltage 100-240V~
Frequency 50-60Hz
Rated current 0,6A@230V-Fuse T5A
Active PFC
Power consumption 105W (all color full power)
- **PHYSICAL**
WxDxH: 355x180x420 mm
Weight: 12 Kg.

EXAMPLE OF CONNECTION DMX CONTROLLER - FIXTURES / ESEMPIO DI COLLEGAMENTO CENTRALINA - FARI

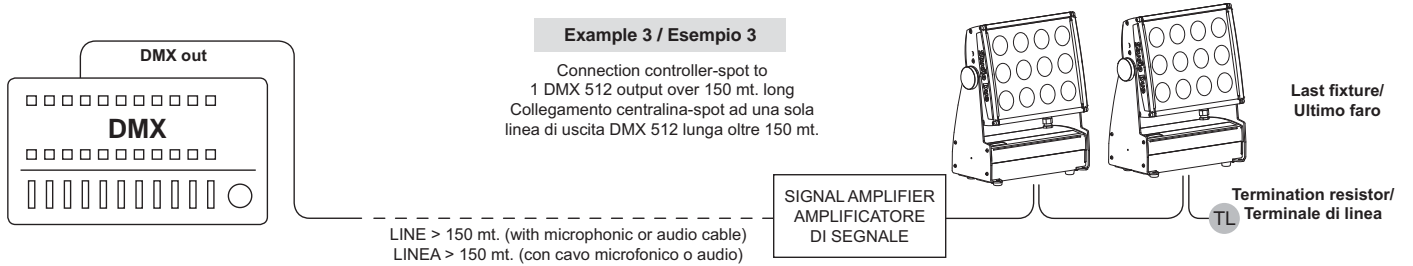
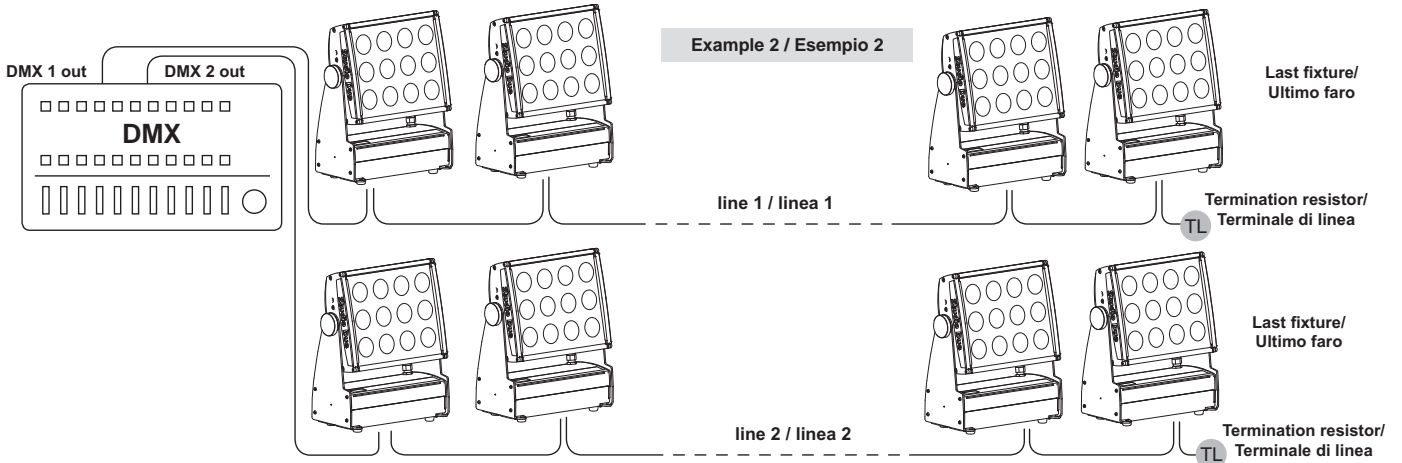
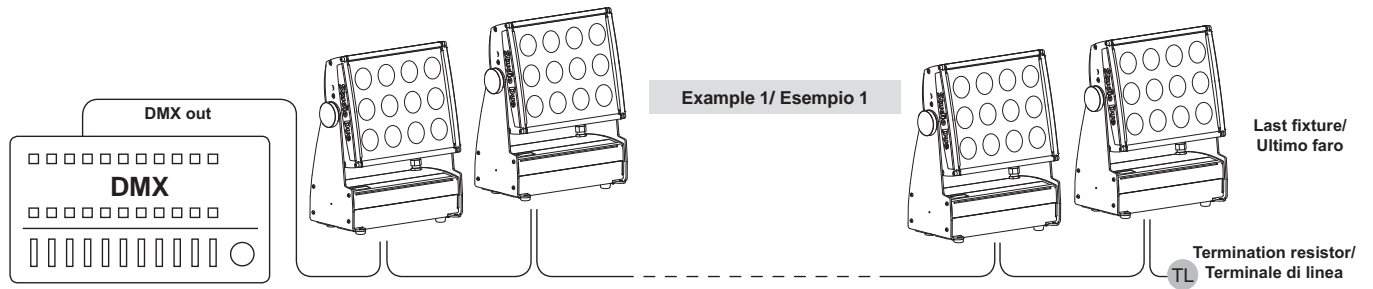

NORMAL AND MASTER/SLAVE FUNCTIONS / FUNZIONI NORMAL E MASTER/SLAVE

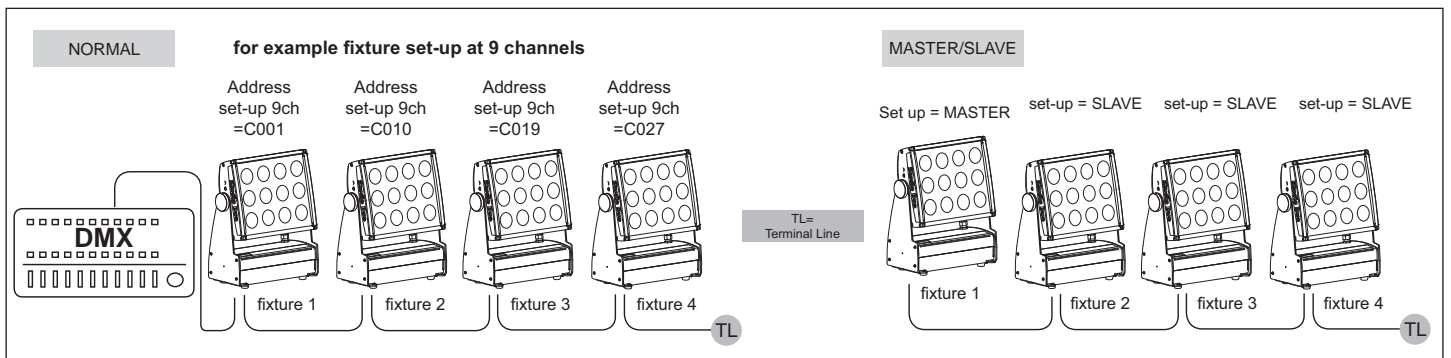

CONNECTION TO THE MAIN POWER / CONNESSIONE ALLA RETE ELETTRICA

eng

This equipment must be earthed.

Class I equipment. The power supply cord includes a protective earthing conductor as part of the cord.

IMPORTANT: to ensure the IP67 protection rating, in case of replacement of the conductor cable, refer to the CONDUCTOR SIZE TABLE

ita

Questo apparecchio necessita di messa a terra.

Apparecchio di Classe I. Il conduttore di protezione deve far parte del cavo di alimentazione.

IMPORTANTE: per garantire il grado di protezione IP67, in caso di sostituzione del cavo di alimentazione, fare riferimento alla TABELLA SEZIONE CONDUTTORE.

! WARNING

HIGH VOLTAGE!

Always disconnect the mains supply before access to the connection area.

ALTA TENSIONE!

Scollegare sempre l'alimentazione prima di aprire il vano dei collegamenti.

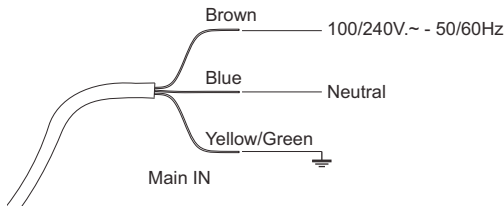

MAIN IN
Ingresso rete



POWER INPUT/ INGRESSO ALIMENTAZIONE Ø 6 - 12mm	
CONDUCTOR SIZES / SEZIONE CONDUTTORE (length / lunghezza < 20mt.)	
MAINS VOLTAGE	CROSS SELECTIONAL AREAS
230V	3X1 mm ² (minimum)

eng

DMX TERMINAL LINE

The wrong connection of the terminal line or its non-connection are probably the most frequent reasons for the defective functioning of the DMX line. The terminator is a terminal resistor fitted at the end of the cable furthest from the transmitter.

The terminal resistor should have the same value as the impedance of the connection cable.

We suggest to use a terminal with a 120 Ohm resistor.

It is recommended that all DMX 512 systems have the terminal resistor fitted in the DMX output of the last fixture.

ita

TERMINALE LINEA DMX

L'incorretto o il mancato collegamento del terminale di linea è probabilmente la più comune causa del difettoso funzionamento della linea DMX. Il terminale di linea DMX consiste in una resistenza posta alla fine della linea.

La resistenza terminale dovrebbe avere idealmente lo stesso valore dell'impedenza del cavo di collegamento.

Noi consigliamo di usare come terminale una resistenza da 120 Ohm.

E' raccomandato per tutti i sistemi DMX 512 inserire il terminale di linea nel connettore uscita DMX dell'ultimo apparecchio collegato.

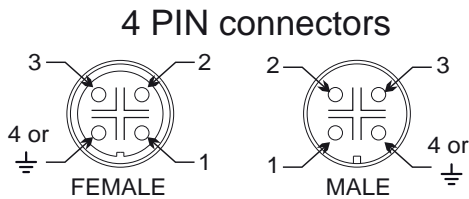

PIN	SIGNAL
1	GROUND/RETURN/OV
2	N.C.
3	DATA COMPLEMENT (-, INVERTED)
4 or ⚡	DATA TRUE (+, NON INVERTED)

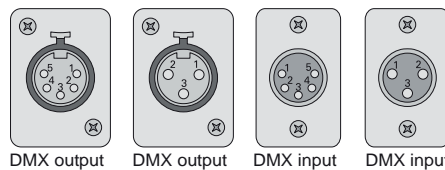

PIN	WIRE	SIGNAL
1	SHIELD	GROUND/RETURN/OV
2	INNER CONDUCTOR	DATA COMPLEMENT (-, INVERTED)
3	INNER CONDUCTOR	DATA TRUE (+, NON INVERTED)

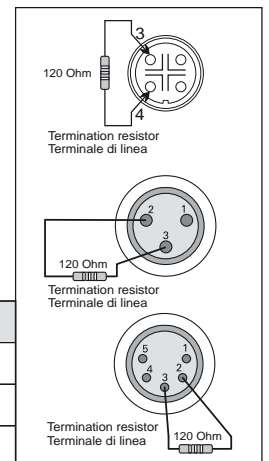

REAR VIEW / VISTA POSTERIORE



DMX OUT (female)
Uscita DMX (femmina)



DMX IN (male)
Ingresso DMX (maschio)

MAIN IN
100-240V~
50-60Hz

DMX OUT

DMX IN

DMX
pin1=SHIELD
pin3=DMX -
pin4=DMX +

 **IP 67**  0,2m

CITYBEAM LED 24
RGBW/FC - art. 1304

Ta 35°C - Tc 75°C

I 1,1A @ 230V~ | 50-60Hz
I 2A @ 120V~ | P. 250W

 **T5A**
MAIN FUSE
inside

 **made in ITALY**

 **Studio Due®**



 **WARNING: Disconnect the unit from power before servicing**
IMPORTANTE: Disconnettere l'apparecchio dalla rete prima di operare

MAIN IN
100-240V~
50-60Hz

DMX OUT

DMX IN

DMX
pin1=SHIELD
pin3=DMX -
pin4=DMX +

 **IP 67**  0,2m

CITYBEAM LED 12
RGBW/FC - art. 1303

Ta 35°C - Tc 75°C

I 0,6A @ 230V~ | 50-60Hz
I 1,3A @ 100V~ | P. 130W

 **T5A**
MAIN FUSE
inside

 **made in ITALY**

 **StudioDue**

 **WARNING: Disconnect the unit from power before servicing**
IMPORTANTE: Disconnettere l'apparecchio dalla rete prima di operare

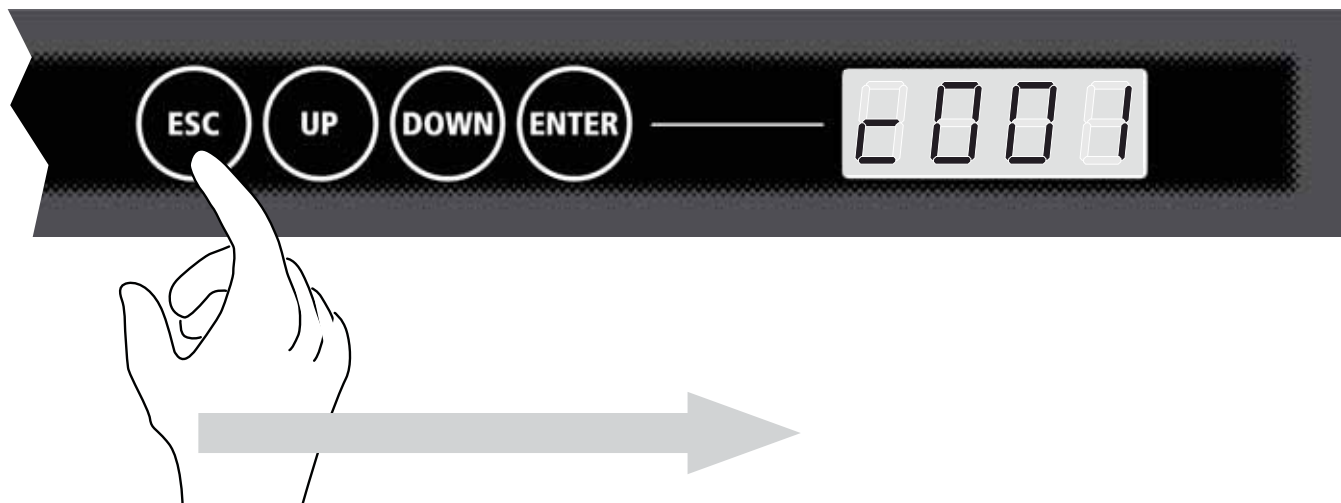

! IMPORTANT

If you want to **enter into setup mode**, you must follow the **start procedure**:
 Se desiderate **entrare nella modalità setup**, dovete seguire la **procedura di accesso**:

Press keys in sequence / Premere i tasti in sequenza:

ESC >> UP >> DOWN >> ENTER

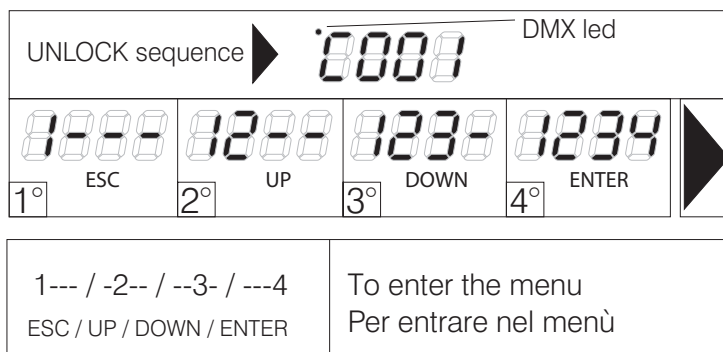

MENU LIST and BUTTON FUNCTIONS - ELENCO MENU' e FUNZIONI DEI PULSANTI



Switching on the fixture you can see the model and the software version. For example:
All'accensione, viene visualizzato il modello di apparecchio e la versione software. Per esempio:

--> City Beam LED --> 1_0c
than it's shown the first DMX channel. When you press any button it's shown the first menu.
poi viene visualizzato il primo canale DMX. Quando si preme qualsiasi pulsante, viene visualizzato il primo menu.

- **UP**: scroll up into the menu / scorre in alto nel menu
- **DOWN**: scroll down into the menu / scorre in basso nel menu
- **ENTER**: enter into the menu/submenu (if present) / entra nel menu/sottomenu (se presente)
- **ESC**: exit from the menu/submenu / esce dal menu/sottomenu

When the display flashing you always must press and hold 1 sec. ENTER to confirm the selected option.
Quando il display lampeggia dovete sempre tenere premuto per 1 sec. ENTER per confermare l'opzione scelta.

menu Address (Addr) > Set the DMX address / Imposta l'indirizzo DMX

AAAA press ENTER / premere ENTER

↳ 0000

- > Select the channel number .. **c001** .. **c002** .. with the UP/DOWN buttons. Press ENTER.
- > Selezionate il canale desiderato .. **c001** .. **c002** .. con i tasti UP/DOWN. Premere ENTER.

menu Display (dISP) > Display functions / Funzioni del display

diSP press ENTER for submenu / premere ENTER per i sottomenu

↳ EE00 **(FLIP)** 180° display rotate / Ruota di 180° il display

- > Select the value **off** .. **on** with the UP/DOWN buttons.
- > Selezionate il valore desiderato **off** .. **on** con i tasti UP/DOWN.

↳ 0000 **(brGt)** Display brightness settings / Impostazioni luminosità del display

- > Select the value **1** .. **7** with the UP/DOWN buttons. Press ENTER.
- > Selezionate il valore desiderato **1** .. **7** con i tasti UP/DOWN. Premere ENTER.

↳ 0000 **(LdMM)** Power LEDS dimmer (with active menu) / Dimmer potenza dei LEDS (con menu attivo)

- > Select the value **off** .. **on** with the UP/DOWN buttons. Press ENTER.
- > Selezionate il valore desiderato **off** .. **on** con i tasti UP/DOWN. Premere ENTER.

menu Auto (AUto) > Auto mode functions / Funzioni auto mode

 press ENTER for submenu / premere ENTER per i sottomenu



(Mode)

Set the DMX/SLAVE/MASTER mode / Imposta la modalità DMX/SLAVE/MASTER

- > Select the value **no** .. **sl** .. **pr01** .. **pr02** .. with the UP/DOWN buttons. Press ENTER.
- > Selezionate il valore desiderato **no** .. **sl** .. **pr01** .. **pr02** .. con i tasti UP/DOWN. Premere ENTER.



(SPd)

Set the preset execution speed / Imposta la velocità di esecuzione dei giochi interni

- > Select the value **+400%** .. **-400%** with the UP/DOWN buttons. Press ENTER.
- > Selezionate il valore desiderato **+400%** .. **-400%** con i tasti UP/DOWN. Premere ENTER.



(ScnE)

Enable or disable the use of a personal scene / Abilita o disabilita l'uso di una scena personale.

- > Select the value **ON** .. **OFF** with the UP/DOWN buttons. Press ENTER.
- > Selezionate il valore desiderato **ON** .. **OFF** con i tasti UP/DOWN. Premere ENTER.

If menu SCENE (ScnE) is enabled, it is possible to create a personal scene (you can create a custom color utilizing the menu which will appear below > RED, GREEN, BLUE, WHITE, WHITE BALANCE, varying the DMX values from 0 to 255 for each color)

Se il menu SCENE (ScnE) è attivo, è possibile creare una scena personale (potete creare un colore personalizzato utilizzando i menu che appariranno di seguito > RED, GREEN, BLUE, WHITE, WHITE BALANCE, variando i valori DMX da 0 a 255 per ogni colore)











For each color or menu it is possible to varying and than set-up the value from 0 to 255 **without having to confirm** with the ENTER key. These functions are auto-save.

Per ogni singolo colore o menu, è possibile variare e quindi impostare il valore da 0 a 255 **senza dover confermare** con il tasto ENTER. Queste funzioni si salvano automaticamente.

- > Select the single color with the UP/DOWN buttons. Press ENTER.
- > Selezionate il colore con i tasti UP/DOWN. Premere ENTER.

- > Select the value **0** .. **255** with the UP/DOWN buttons. Don't press ENTER.
- > Selezionate il valore desiderato **0** .. **255** con i tasti UP/DOWN. Non premere ENTER.

ScnE (scene) menu available from software version 2.00
ScnE (scene) menu disponibile dalla versione software 2.00

menu **Utility (UtlL)** > **Utility functions / Funzioni di utilità**



press ENTER for submenu / premere ENTER per i sottomenu



(SMth)

Set the interpolation type for the smooth dimming function
Imposta il tipo di interpolazione per la funzione smooth dimming

- > Select the value **off** .. **LoW** .. **Mld** .. **hGH** with the UP/DOWN buttons. Press ENTER.
- > Selezionate il valore desiderato **off** .. **LoW** .. **Mld** .. **hGH** con i tasti UP/DOWN. Premere ENTER.



(hALo)

Set the alogen simulation function mode
Imposta il funzionamento della modalità simulazione lampada alogena

- > Select the value **off** .. **Mld1** .. **Mld2** with the UP/DOWN buttons. Press ENTER.
- > Selezionate il valore desiderato **off** .. **Mld1** .. **Mld2** con i tasti UP/DOWN. Premere ENTER.



(cyM)

Set the fixture to work in CYM or RGB emulation system
Imposta l'apparecchio per funzionare come emulatore di sistema CYM o RGB
(see DMX channels page - vedere pag. canali DMX)

- > Select the value **off** >> **RGB** or **on** >> **CYM** with the UP/DOWN buttons. Press ENTER.
- > Selezionate il valore desiderato **off** >> **RGB** or **on** >> **CYM** con i tasti UP/DOWN. Premere ENTER.

menu Service (Srv) > Service functions / Funzioni di servizio

5800 press ENTER for submenu / premere ENTER per i sottomenu

FrMt

(FrMt)

Restore the factory setting (Require confirmation) **FM-?**
Ripristina le impostazioni di fabbrica (Viene chiesta conferma) **FM-?**

- > Select the value **off .. on** with the UP/DOWN buttons. Press ENTER.
- > Selezionate il valore desiderato **off .. on** con i tasti UP/DOWN. Premere ENTER.

tEst

(tEst)

Enables the fixture test and execute a factory program to check the right functioning.
Abilita il test dell'apparecchio ed esegue un programma di fabbrica per verificarne il funzionamento

- > Select the value **t-on** with the UP/DOWN buttons. T-on is flashing, the test is in progress. Press any key to exit.
- > Selezionate il valore desiderato **t-on** con i tasti UP/DOWN. T-on lampeggia, il test è in corso. Premere qualsiasi tasto per uscire.

nchn

(nchn) Set the DMX channels of the fixture / Imposta il numero di canali DMX dell'apparecchio

- > Select the value **9 .. 5 .. 4** with the UP/DOWN buttons. Press ENTER. (see DMX channel page)
- > Selezionate il valore desiderato **9 .. 5 .. 4** con i tasti UP/DOWN. Premere ENTER. (vedere pag. canali DMX)

FLcr

(FLcr) Flicker free function / Funzione flicker free
from 2.09 software version / dalla versione software 2.09

- > Select the value **f1 .. f2** with the UP/DOWN buttons. Press ENTER.
- > Selezionate il valore desiderato **f1 .. f2** con i tasti UP/DOWN. Premere ENTER.

ntc

(ntc) Service personnel only / Solo personale di servizio

menu Wireless (WLSS) > Wireless functions / Funzioni wireless

0055 press ENTER for submenu / premere ENTER per i sottomenu

EnAb

(EnAb) Enable wireless

Enable or disable the wireless reception / Consente o non consente la ricezione wireless
The cable reception is disabled / La ricezione via cavo viene disabilitata

- > Select the value **on .. off ..** with the UP/DOWN buttons. When the written is flashing, press ENTER.
- > Selezionate il valore desiderato **on .. off ..** con i tasti UP/DOWN. Quando la scritta lampeggia, premere ENTER.

UnLn

(UnLn) Unlink transmission

Remove the link from the fixture to the associated transmitter / Elimina il link tra
l'apparecchio e il trasmettitore al quale è stato associato

- > Select the value **on .. off ..** with the UP/DOWN buttons. When the written is flashing, press ENTER.
- > Selezionate il valore desiderato **on .. off ..** con i tasti UP/DOWN. Quando la scritta lampeggia, premere ENTER.

brdG

(brdG) Bridge function

If wireless is ON, enable the transmission of the received data by cable to the other fixtures /
Se il wireless è attivo, consente la trasmissione dati agli altri apparecchi collegati via cavo.

- > Select the value **on .. off ..** with the UP/DOWN buttons. Press ENTER.
- > Selezionate il valore desiderato **on .. off ..** con i tasti UP/DOWN. Premere ENTER.

Ln

(Ln)

This menu will be active in the future / Questo menu sarà attivo in futuro

DMX CHANNELS / CANALI DMX

• 9 Channels mode • Modalità 9 Canali

CH1: Red
 CH2: Green
 CH3: Blue
 CH4: White
 CH5: Strobe
 CH6: Dimmer
 CH7: Led Fade Time
 CH8: Rainbow
 CH9: Fix White (Balanced White)

• 5 Channels mode • Modalità 5 Canali

CH1: Red
 CH2: Green
 CH3: Blue
 CH4: White
 CH5: Dimmer

• 4 Channels mode • Modalità 4 Canali

CH1: Red
 CH2: Green
 CH3: Blue
 CH4: White

• 9 Channels mode with CYM emulation • Modalità 9 Canali con emulazione CYM

CH1: Cyan
 CH2: Yellow
 CH3: Magenta
 CH4: White
 CH5: Strobe
 CH6: Dimmer
 CH7: Led Fade Time
 CH8: Rainbow
 CH9: Fix White (Balanced White)

• 5 Channels mode with CYM emulation • Modalità 5 Canali con emulazione CYM

CH1: Cyan
 CH2: Yellow
 CH3: Magenta
 CH4: White
 CH5: Dimmer

• 4 Channels mode with CYM emulation • Modalità 4 Canali con emulazione CYM

CH1: Cyan
 CH2: Yellow
 CH3: Magenta
 CH4: White

DMX Channels list 9Ch / Lista dei canali DMX 9Ch

8bit	FUNCTION	0	31	63	95	127	159	191	223	255	
Ch1	RED										
Ch2	GREEN										
Ch3	BLUE										
Ch4	WHITE										
Ch5	Strobe	<p>0-1 Open Flash 0,4Hz / 25Hz 2-127 Rainbow-Flash 0,4Hz / 25Hz 128-255</p>									
Ch6	Dimmer										
Ch7	Led fade time	<p>0=CUT 0,1 sec. FAST LINEAR SLOW 25,5 sec.</p>									
Ch8	Rainbow										
Ch9	Balanced white	<p>0-15 normal 16-255</p>									

DMX Channels list 5Ch / Lista dei canali DMX 5Ch

8bit	FUNCTION	0 31 63 95 127 159 191 223 255									
		[Checkered bar]									
Ch1	RED	[Slider from 0 to 255 with red gradient]									
Ch2	GREEN	[Slider from 0 to 255 with green gradient]									
Ch3	BLUE	[Slider from 0 to 255 with blue gradient]									
Ch4	WHITE	[Slider from 0 to 255 with grayscale gradient]									
Ch5	Dimmer	[Slider from 0 to 255 with grayscale gradient]									

DMX Channels list 4Ch / Lista dei canali DMX 4Ch

8bit	FUNCTION	0 31 63 95 127 159 191 223 255									
		[Checkered bar]									
Ch1	RED	[Slider from 0 to 255 with red gradient]									
Ch2	GREEN	[Slider from 0 to 255 with green gradient]									
Ch3	BLUE	[Slider from 0 to 255 with blue gradient]									
Ch4	WHITE	[Slider from 0 to 255 with grayscale gradient]									

Click on the QR Code with your smartphone to go directly to the website
 Clicca sul codice QR con il tuo smartphone per accedere direttamente al sito web



STUDIODUE s.r.l.
 str. Poggiano, 100 - 01100 VITERBO ITALY - tel. +39 0761 352520 - fax +39 0761 352653

<http://www.studiodue.com> E-Mail: info@studiodue.com - service@studiodue.com

BUILT IN PROGRAMS / LISTA DEI GIOCHI

Here below the list of 24 preset of the fixture.

Qui di seguito la lista dei 24 giochi presenti nell'apparecchio.

Preset 1	Fixed RED
Preset 2	Fixed GREEN
Preset 3	Fixed BLUE
Preset 4	Fixed WHITE (w)
Preset 5	Fixed MAGENTA
Preset 6	Fixed YELLOW
Preset 7	Fixed CYAN
Preset 8	COLOR CHANGE FAST (Red, Green, Blue, Magenta, Yellow, Cyan, White) Color change no fade
Preset 9	COLOR CHANGE SLOW (Red, Green, Blue, Magenta, Yellow, Cyan, White) Color change with 2,5 sec. fade
Preset 10	RAINBOW SLOW
Preset 11	RAINBOW MID
Preset 12	RAINBOW FAST
Preset 13	WHITE BALANCE (from cool)
to
Preset 18	WHITE BALANCE (to warm)
Preset 19	SIMULATION SODIUM lamps (yellow type)
to
Preset 24	SIMULATION SODIUM lamps (yellow type)

PHYSICAL CITYBEAM LED 24 / DIMENSIONI CITYBEAM LED 24

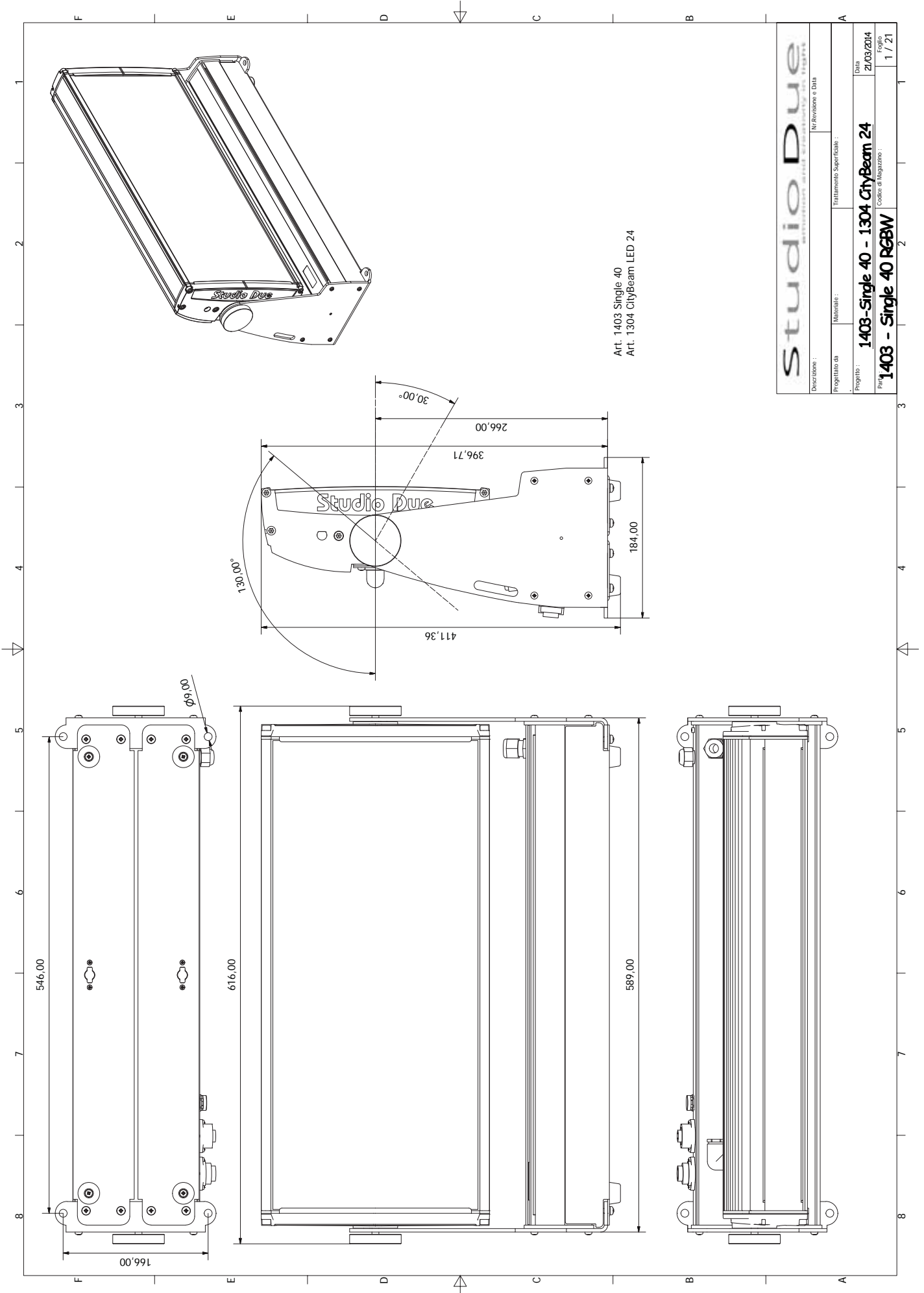

PHYSICAL CITYBEAM LED 12 / DIMENSIONI CITYBEAM LED 12

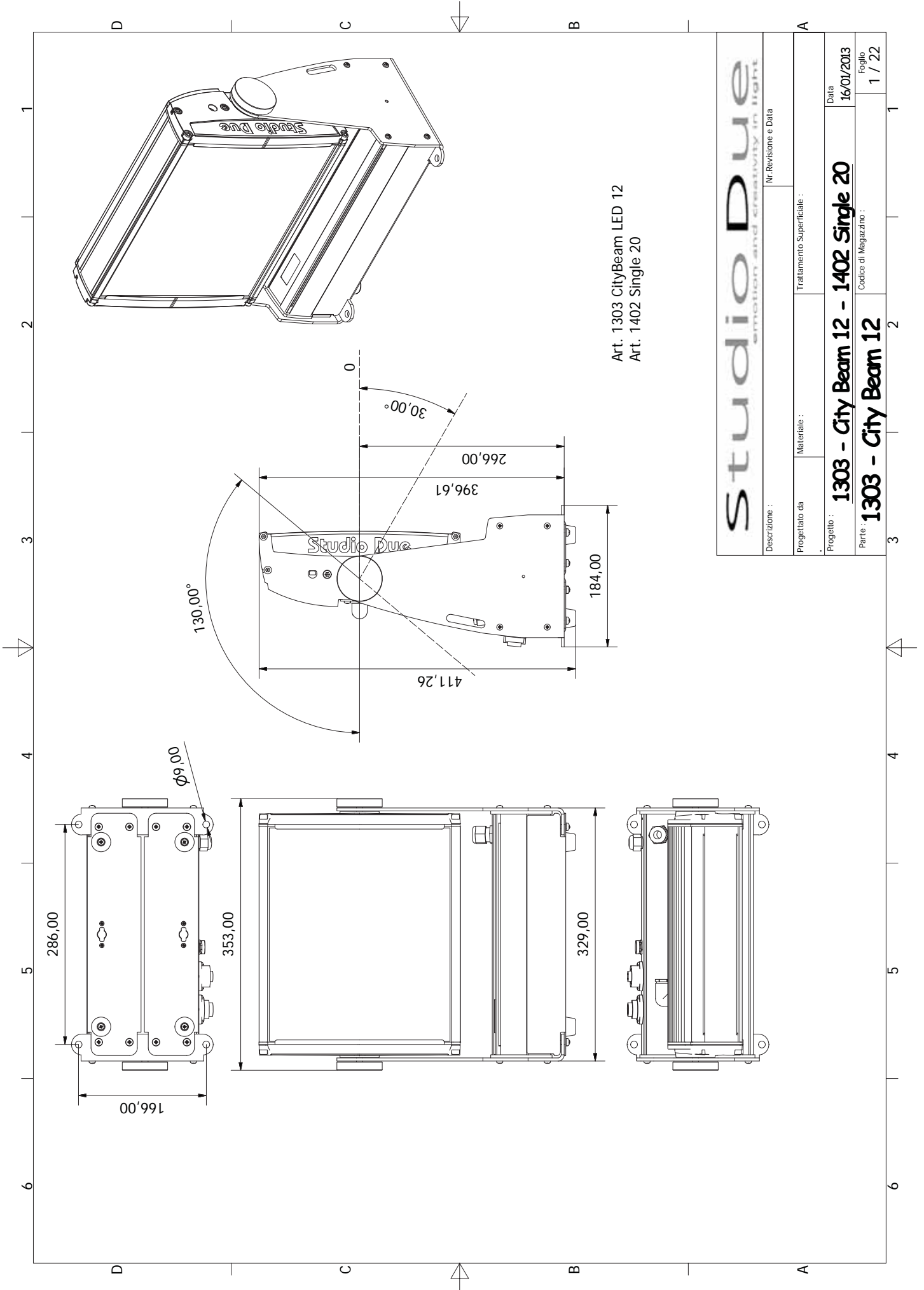

Dichiarazione CE di conformità Declaration CE of conformity

La ditta: STUDIO DUE light s.r.l.
The firm: Strada Poggino, 100
 01100 VITERBO
 ITALY

dichiara sotto la propria responsabilità che il prodotto:
declare under our sole responsibility that the product:

CITYBEAM LED 12 RGBW/FC (full color) IP67 code 1303

è conforme alle norme: CE
is in conformity with the standard: CE

Low Voltage Directive: 2014/35/EU

EN 60529:1991 + A1:2000 + A2:2013
EN 62471:2008
EN 60598-1:2015
EN 60598-2-17:1989 + A2:1991

ECM Directive: 2014/30/EU

EN 61000-3-2:2014	EN 61000-4-2
EN 61000-3-3:2013	EN 61000-4-3
EN 61547:2009	EN 61000-4-4
EN 55103-2:2009	EN 61000-4-5
EN 55015:2013	EN 61000-4-6
EN 55103-1:2009 + A1:2012	EN 61000-4-11

e quindi ai requisiti essenziali delle Direttive:
and therefore according to essential requirement of Directives:

2004/108/EC – Electromagnetic compatibility
2006/95/EC – Low Voltage directive

Data di apposizione CE : 13
Date of CE marking : 13

VITERBO, 03/06/13

PAOLO SENSI
General Manager

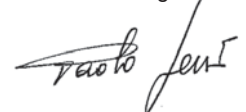

Dichiarazione CE di conformità

Declaration CE of conformity

La ditta: STUDIO DUE light s.r.l.
The firm: Strada Poggino, 100
01100 VITERBO
ITALY

dichiara sotto la propria responsabilità che il prodotto:
declare under our sole responsibility that the product:

CITYBEAM LED 24 RGBW/FC (full color) IP67 code 1304

è conforme alle norme: CE
is in conformity with the standard: CE

Low Voltage Directive: 2014/35/EU

EN 60529:1991 + A1:2000 + A2:2013
EN 62471:2008
EN 60598-1:2015
EN 60598-2-17:1989 + A2:1991

ECM Directive: 2014/30/EU

EN 61000-3-2:2014	EN 61000-4-2
EN 61000-3-3:2013	EN 61000-4-3
EN 61547:2009	EN 61000-4-4
EN 55103-2:2009	EN 61000-4-5
EN 55015:2013	EN 61000-4-6
EN 55103-1:2009 + A1:2012	EN 61000-4-11

e quindi ai requisiti essenziali delle Direttive:
and therefore according to essential requirement of Directives:

2004/108/EC – Electromagnetic compatibility
2006/95/EC – Low Voltage directive

Data di apposizione CE : 13
Date of CE marking : 13

VITERBO, 03/06/13

PAOLO SENSI
General Manager

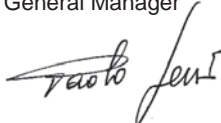

WARRANTY CARD

Studio Due®

Company name:

Mr./Mrs./Miss:

Address:

Tel. or E-mail :

Dealer:

SALE CONDITIONS

1) Price quoted are not inclusive of lamp and package.
Package charge is 2% on the net price for all the items, except for art. 0403 (CS4), that is 4%.
These prices should be subject to possible variations for eventual rises of production costs or duties.
Claims for possible damages during the freight, must be notified to the carrier.
Any claim must be notified within 8 days from the receipt of the goods.
The buyer is responsible of the right installation and use of the apparatus.
All the apparatuses are guaranteed for one year against defects of manufacture or materials.
Defects and breakages caused by wrong connection or use of the apparatuses are not subject to guarantee.
The lamp is excluded from the warranty.
For any dispute is competent the Tribunal of Viterbo.

CONDIZIONI DI VENDITA

1) I prezzi riportati sono esclusi di IVA, lampada ed imballaggio.
Il costo di imballaggio è del 2% sul prezzo netto per tutti gli articoli, eccetto per l'art. 0403 (CS4) che è del 4%.
Detti prezzi possono essere soggetti a possibili variazioni per eventuali aumenti dei costi di produzione o imposte.
La merce viaggia a rischio e pericolo del committente, anche se in porto franco.
Reclami per possibili danni durante il trasporto, dovranno essere fatti esclusivamente al vettore.
Eventuali osservazioni sulle merci ricevute dovranno esserci notificate entro e non oltre 8 giorni dal ricevimento delle medesime.
Sui ritardi dei pagamenti verrà conteggiato l'interesse commerciale.
L'acquirente si impegna a comunicare la propria esatta ragione sociale e partita IVA al momento dell'ordine e sotto la propria responsabilità di verificarla in fattura.
L'acquirente è responsabile della corretta installazione ed uso delle apparecchiature.
Tutte le apparecchiature godono della garanzia di un anno contro difetti di fabbricazione o di materiali, sono esclusi dalla garanzia danni derivanti da un cattivo uso o installazione delle apparecchiature.
Le lampade restano comunque escluse dalla garanzia.
Per ogni controversia è competente il Foro di Viterbo.

this page is intentionally left blank

Studio Due

Head Office: STUDIO DUE s.r.l. (I)

Str. Poggino, 100 - 01100 Viterbo (Italy)
tel. +39.0761.352520
fax +39.0761.352653
info@studiodue.com

STUDIO DUE (UK)

3 Encon Court Owl Close
Moulton Park Industrial Estate
Northampton England UK - NN3 6 HZ
tel. +44.1933.650.820
info@studiodue.co.uk

www.studiodue.com
for technical info
service@studiodue.com