

# DAUS - 861

DAUS - 8 COLOURS LED 150W



- **Type:** Asymmetric washlight
- **Source:** 8 colours LED 150W
- **Optics:** Asymmetric

Asymmetric

## The perfect LED alternative to traditional washlights!

Sharing the same qualities of control, colour mixing, coverage and silent operation as Dalis Cyclight, Dalis 861 is the perfect wash complement to the Dalis range. Configured into a rectangular format with 24 asymmetrical micro-reflectors and 8 LED emitters (6 colours plus a warm and a cool white) arranged in four rows, Dalis washlight gives access to a wide variety of saturated colours and pastel tones. Offering a very wide opening and a perfect even coverage, it is an ideal solution for side lighting, low-level light for dance, and as a short-form cyclorama luminaire when space is at premium.

### Features

- **8-colour mixing LED system:** red, Green, Blue, Royal Blue, Amber, Cyan, Warm White (2200K), Cool White (6500K)
- **Very wide colour gamut:** the choice of the eight colours in association with the 16-bit control, results in an almost infinite range of repeatable colour possibilities
- **Impressive range of pastel tones:** desaturation of the colours possible with the addition of the Warm White and Cool White LEDs - no need to dim the light output
- **True tunable white:** from 2200K to 6500K - full spectrum to light backdrop
- **16-bit control of each colour:** precision dimming on every colour
- **Linear dimming curve:** no colour fading during dimming
- **Adjustable response time:** choice of fast or slow dimming for tungsten-like simulation - adjustment by DMX protocol
- **Strobe:** independent control of speed and duration
- **Easy control mode available:** preset calibrated colours with control of intensity and CCT
- **Universal data control:** compatible with DMX, RDM, Art-Net, sACN protocols
- **Easy setup:** locally and remotely by RDM protocol - integrated display
- **Angular sensor:** tilt angle displayed for perfect alignment of all the units
- **Dimming parameters:** choice of square or linear dimming curves
- **Tilt reference on hanging yoke:** index for rapid re-positioning

### Optical

- **Exclusive patented optical system:** 24 micro optical asymmetric reflectors delivering superbly smooth coverage across any surface
- **High efficiency:** massive light output, small power consumption
- **Long life:** outstanding operational lifetime expectation, no need to replace lamps, low maintenance
- **Perfect white:** the combination of the 2 whites with the 6 colours enables to produce white variations with very high quality (CRI >97) and high brightness
- **High transmissive coated protective glass window:** ensures optimal light transmission
- **Electronic dimmer:** dimming without clipping or cut-out at low intensity levels; high quality smoothing

### Construction

- **Made in Europe:** control over all aspects of quality
- **PSU:** built-in electronic flicker-free power supply for easy, plug-and-play installation
- **Ethernet-DMX node:** data IN through RJ45 connector; data OUT through DMX for daisy chaining
- **Power connectors:** neutriK® powerCON TRUE1 IN and OUT connectors for daisy chaining; delayed power out switching against inrush current
- **Fanless system:** convection cooling- perfect for sound sensitive applications - less maintenance required
- **Electronic thermal management system:** ensures maximum performance of the system without any risk of overheating

Picture:861

DSEN287\_861 - 07/01/2020

Robert Juliat reserves the right to change or alter any of the items detailed on this page, to increase or improve manufacturing techniques without prior notice.

Robert Juliat S.A.S., 32 rue de Beaumont, 60530 Fresnoy-en-Thelle - France  
Telephone : +33 (0)3 44 26 51 89 - fax : +33 (0)3 44 26 90 79 - info@robertjuliat.fr  
www.robertjuliat.com



ROBERT JULIAT

## Source

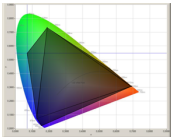

- **Lamp type:** LED - 8 colours
- **Power:** 138 W
- **Lumen output:** 10239 lm
- **Life:** 40000 hours (LM70)

Colours	Power *	Lumen output*	Colour temperature*	CRI* (min)
Red	9 W	694 lm		
Green	13 W	1 000 lm		
Blue	13 W	350 lm		
Royal blue	13 W	1 923 lm		
Cyan	12 W	448 lm		
Amber	13 W	592 lm		
Warm white	33 W	1 992 lm	2200K	80
Cool white	33 W	3 240 lm	6500K	70

(\*) manufacturer's data

## Optics

### Characteristics

- **Type:** Asymmetric
- **Horizontal spread:** °
- **Vertical spread:** 90°

## Installation and photometrics

**Field lumens**

7 000 lm

**Efficacy**

49 lm/W

## Remote control

• **Data protocol:** USITT DMX512-A  
RDM / Art-Net / sACN

• **Data IN connector:** 5 pins XLR male + RJ45  
• **Data OUT connector** 5 pins XLR female



### • DMX chart:

#### Mode 1 (22 channels)

Dimmer @16b  
8 colours @16b  
Strobe: duration + speed  
Response time  
Control mode

#### Mode 2 (13 channels)

Dimmer @8b  
8 colours @8b  
Strobe: duration + speed  
Response time  
Control mode

#### Mode 3 (8 channels)

Dimmer @16b  
Colour presets  
CCT  
Strobe: duration + speed  
Response time  
Control mode

#### Mode 4 (7 channels)

Dimmer @8b  
Colour presets  
CCT  
Strobe: duration + speed  
Response time  
Control mode

## Dimensions and weight

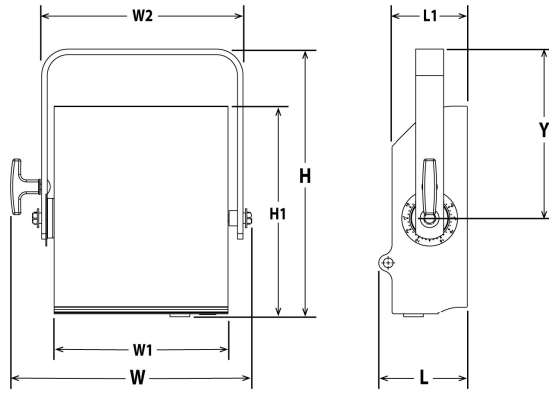

**Weight:** 6.5 kg (14.3 lbs)

Height	Length	Width	Yoke	Tilt	Option
H= 385 mm (15.2 in) H1= 303 mm (11.9 in)	L= 127 mm (5 in) L1= 108 mm (4.3 in)	W= 346 mm (13.6 in) W1= 250 mm (9.8 in) W2= 289 mm (11.4 in)	Y= 243 mm (9.6 in)	TD= 90°	TO= 90°

## Shipping

- **Weight :** 8.2 kg (18 lbs)
- **Volume :** .04 m<sup>3</sup> (1.34 ft<sup>3</sup>)

## Installation

- **Minimum distance to illuminated surface:** 0.2 m ( 0.7 ft )
- **Operating position:**



## Construction

- **Housing:** Steel sheet - Aluminium
- **Colour:** Black
- **Cooling:** Convection cooling
- **Maximum ambient temperature (Ta):** 40°C (104°F)
- **Maximum case temperature (Tc):** 70°C (158°F)
- **Total heat dissipation:** 481 BTU/h
- **Protection rating:** 20

## Electrical compatibility

- 220/230 V - 50 Hz
- 245 V - 50 Hz
- 110/120 V - 60 Hz
- 208 V - 60 Hz
- 220/230 V - 60 Hz
- 100 V - 50 Hz
- 100 V - 60 Hz
- Selector: automatic detection

## Power input



- **Type:** Neutrik powerCON TRUE1 (connector included)

## Power consumption

Voltage	Frequency	Current	Power	Power factor
230 V	50 Hz	0.8 A	141 W	0,72
120 V	60 Hz	1.3 A	143 W	0,91
100 V	60 Hz	1.5 A	142 W	0,92

## Power Supply Unit

- **PSU:** Internal - Electronic PSU - Flicker free with PFC
- **Control:** Local / DMX
- **Protection:** -
- **Power thru:** Neutrik powerCON TRUE1 - Maximum of 20 units (230 V) / 10 units (120 V)

## Warranty

- **Fixture: 3 years**  
See General Sales Condition on website

## Approvals







## Model

**861**

8 colours LED 150W Asymmetric washlight - 861 Dalis

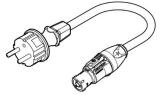
## Options

## Accessories

<b>CAL03</b>	3 meter power cable ( 3G1,5 HO7RNF) with Neutrik PowerCon© True1 and CEE 7/7 (2P+T NF/SCHUKO) connectors	
<b>CAL05</b>	Combined Neutrik PowerCon© True1 / DMX (5 pins) patch cable - length: 1m	
<b>872</b>	Doughty "Twenty clamp" with M10 screw/nut for Ø48 to 51mm pipes - SWL: 20Kg - TÜV approved - Weight: ,25 Kg	
<b>876</b>	Hook clamp 40x10mm with 28mm M10 screw for Ø35 to 50mm pipes - SWL: 50Kg - Weight: 1,25 Kg	
<b>880</b>	Hook clamp 40x10mm with 28mm M10 screw for Ø50 to 63mm pipes - SWL: 50Kg - Weight: 1,36 Kg	
<b>CS2</b>	Safety cable Ø3 mm L= 600mm - SWL: 75 Kg	