

ZEP - 643SXWW

6405X - LED 150 W



- **Type:** Profile spot
- **Source:** LED 150 W
- **Optics:** 28° to 54° zoom
- **Colour temperature:** Warm white

Profile spot

The new powerful LED profile

An evolution of the award-winning 85 W LED profile, incorporating an innovative and powerful 150 W LED engine, the RJ ZEP profile is designed to offer a higher light output - equivalent to a 1000 W tungsten profile spot - together with very low power consumption. Designed with Robert Juliat's trademark qualities of ergonomic perfection, optical and mechanical excellence, ZEP features an excellent colour rendering index and suit every application from the smallest theatre to the largest spectacular.

Features

- **Multi-function double gate:** Simultaneous use of gobos and iris. Sharp focus of both gobo and shutter
- **Shutter gate:** Up to 8 shutters. Remove shutters for easy maintenance or tuck fully inside gate for secure transport
- **User-friendly shutter-lock system:** Secures shutters' setting in any circumstances (locking efficient up to 4 shutters)
- **Universal gobo holder:** A-size plastic, glass and metal gobo
- **90° rotating lens tube / gate / front accessories holder:** Rotation of the projected image is always possible – no need to move the yoke
- **Internal glass filter holder:** Long term use of durable coloured, dichroic and textured glass or gels
- **DMX:** 8 or 16 bits dimming and strobe function
- **Parameters:** Adjustable curves and response thru 4-button display with automatic light switch-off
- **Control:** Local, DMX, wireless DMX (option)
- **Easy focus reference:** Graduated scale on side of lantern; fast and easy refocusing
- **Tilt reference on hanging yoke:** Index for rapid re-positioning

Optical

- **Very long-life lamp source:** 50 000 hours - Lumen maintenance greater than 70% after 50 000 hours
- **SX optical system:** Double condenser optics for exceptional optical quality
- **Variable zoom optics:** Sharp focus at every beam angle. Independent control of image size and focus. Focus handles on both sides
- **Perfect dimming:** No clipping or cut-out below 20%; high quality smoothing

Construction

- **Made in France :** Fully manufactured on the premises retaining complete control over all aspects of quality
- **PSU:** Built-in electronic flicker-free power supply for easy, plug and play installation
- **Power connectors:** NeutriK® powerCON TRUE1 in and out connectors for daisy chaining
- **Silent-running cooling fans:** Ideal for TV studios and opera houses
- **Bodywork:** Strong sheet metal construction for durability
- **Captive knobs and handles:** Additional security when working at height or in transit
- **Spare parts and accessories:** Uniform across the tungsten, discharge or LED range, reducing running costs
- **Easy access to all parts:** Easy cleaning and maintenance

Picture:643SX

DSEN164_643SXWW - 04/05/2016

Robert Juliat reserves the right to change or alter any of the items detailed on this page, to increase or improve manufacturing techniques without prior notice.

Robert Juliat S.A.S., 32 rue de Beaumont, 60530 Fresnoy-en-Thelle - France
Telephone : +33 (0)3 44 26 51 89 - fax : +33 (0)3 44 26 90 79 - info@robertjuliat.fr
www.robertjuliat.com



ROBERT JULIAT

Source

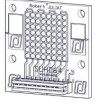

- **Lamp type:** LED
- **Power:** 150 W

LED specifications	Power *	Lumen output*	Colour temperature*	Life*	CRI* (min)
SUHD64 WW N (RJ / Osram)	150 W	8 000 lm	3200K	50 000 h	82

(*) manufacturers data

Optics

Characteristics

- **Type:** Zoom
- **Beam range:** 28° to 54°
- **Focal length:** 79 - 160 mm

Gel filter

- **Shape:** Square
- **Standard size:** 180x180 mm (7.1x7.1 in)
- **Optional size:** 185x185 mm (7.3x7.3 in)

Gobo

- **Size:** A
- **Material:** Metal
Glass
Plastic

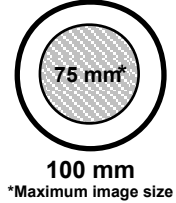

Photometrics

with source

• Optics @ 28°

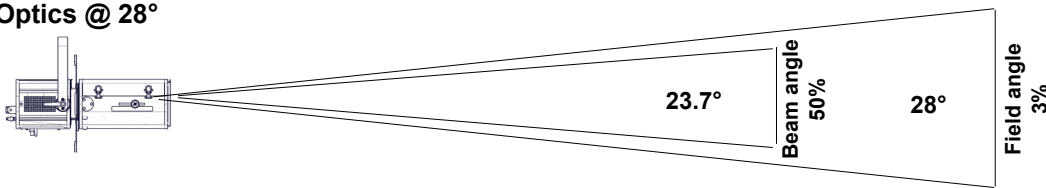

Beam intensity
37 000 cd

Field lumens
4 530 lm

Efficacy
31 lm/W

CCT
3 350 K

Distance	3 m	5 m	7 m	10 m	12 m	15 m
Diameter	1.5 m	2.5 m	3.5 m	5 m	6 m	7.5 m
Illumination	4 150 lux	1 500 lux	760 lux	380 lux	260 lux	170 lux
Distance	10 ft	15 ft	25 ft	35 ft	40 ft	50 ft
Diameter	5 ft	7.5 ft	12.5 ft	17.5 ft	19.9 ft	24.9 ft
Illumination	380 fc	170 fc	60 fc	31 fc	24 fc	15 fc

• Optics @ 54°

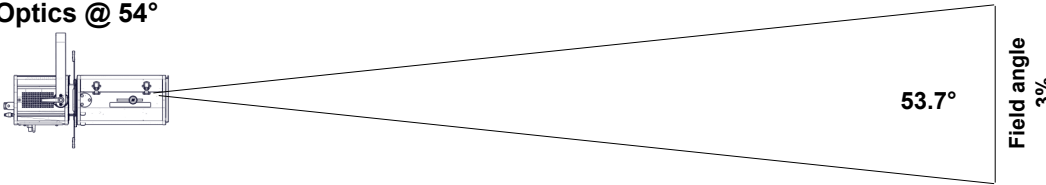

Beam intensity
11 800 cd

CCT
3 300 K

Distance	3 m	5 m	7 m	10 m	12 m	15 m
Diameter	3 m	5.1 m	7.1 m	10.1 m	12.1 m	15.2 m
Illumination	1 350 lux	480 lux	250 lux	120 lux	85 lux	55 lux
Distance	10 ft	15 ft	25 ft	35 ft	40 ft	50 ft
Diameter	10.1 ft	15.2 ft	25.3 ft	35.4 ft	40.5 ft	50.6 ft
Illumination	120 fc	55 fc	19 fc	10 fc	8 fc	5 fc

Remote control

- **Data protocol:** USITT DMX512-A

- **Data IN connector:** 5 pins XLR male
- **Data OUT connector:** 5 pins XLR female



• DMX chart:

Mode 1 (1 channels)
Dimmer

Mode 2 (2 channels)
Dimmer
Strobe

Mode 3 (2 channels)
Dimmer
Dimmer fine

Mode 4 (3 channels)
Dimmer
Dimmer fine
Strobe

Dimensions and weight

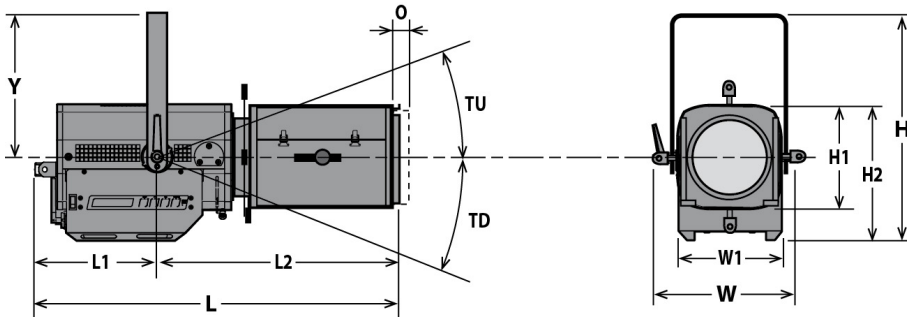

Weight: 15.3 kg (33.7 lbs)

Height	Length	Width	Yoke	Tilt	Option
H= 447 mm (17.6 in)	L= 682 mm (26.9 in)	W= 330 mm (13 in)	Y= 280 mm (11 in)	TU= 60°	O= 25 mm (1 in)
H1= 208 mm (8.2 in)	L1= 241 mm (9.5 in)	W1= 208 mm (8.2 in)		TD= 90°	
H2= 268 mm (10.6 in)	L2= 441 mm (17.4 in)				

Shipping

- **Weight :** 18.2 kg (40 lbs)
- **Volume :** .13 m³ (4.52 ft³)

Installation

- **Minimum distance to illuminated surface:** 0.4 m (1.1 ft)
- **Operating position:**

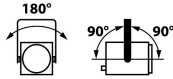

Construction

- **Housing:** Steel sheet - Aluminium
- **Colour:** Black
- **Cooling:** Low noise variable fan
- **Maximum ambient temperature (Ta):** 40°C (104°F)
- **Maximum case temperature (Tc) :** 65°C (149°F)
- **Total heat dissipation:** 631 BTU/h
- **Protection rating:** 20

Warranty

- **Period: 2 years**
See General Sales Condition on website

Approvals



Electrical compatibility

- 220/230 V - 50 Hz
- 245 V - 50 Hz
- 110/120 V - 60 Hz
- 208 V - 60 Hz
- 220 V - 60 Hz
- 100 V - 50 Hz
- 100 V - 60 Hz
- Selector: automatic detection

Power input



- **Type:** removeable power cord with Neutrik powerCON TRUE1 connector (included)
- **Cable:** H07RNF 3G1.5
- **Length:** 3 m (9,8 ft)
- **Power connector:** CEE 7/7 (2P+E NF/Schuko)

Power consumption

Voltage	Frequency	Current	Power	Power factor
230 V	50 Hz	0.8 A	185 W	>0.95
120 V	60 Hz	1.5 A	185 W	>0.98
100 V	60 Hz	1.8 A	185 W	>0.98

Power Supply Unit

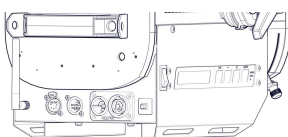





- **PSU:** Internal - Electronic PSU - Flicker free with PFC
- **Control:** Local / DMX
- **Protection:** Mains: 4A 1P1D breaker - UL /
- **Power thru:** Neutrik powerCON TRUE1 - Maximum of 19 units (230 V) / 10 units (110 V)











Model

643SXWW	LED 150 W Profile spot - 643SXWW ZEP - Warm White - 28/54°
----------------	--

Options

LT-Profile	Licht-Technik motorisation controlled by DMX: Pan, tilt, zoom, focus, 4 shutters, colour changer	
CAV600	Double slot front cassette for 180x180mm accessories	
CAV600E	Double slot front cassette for 185x185mm accessories	
PCP1716A	16A blue 2P+E 6h IEC60309 power connector	
W-DMX/Z	W-DMX wireless DMX	

Accessories

D8	Shutter for SX series 4 included	
PF500M2	180x180mm metal filter holder 1 included	
SGUX	Universal "A" size gobo-holder (metal, glass, frosted glass) 1 included	
IWSX755	Drop-in iris (monoplane) with holder - Weight: ,26 Kg	
G500	180x180mm safety grid	
CAV600A	Double slot front cassette for 180x180mm accessories - Weight: ,43 Kg	
CAV600AE	Double slot front cassette for 185x185mm accessories - Weight: ,45 Kg	
VD120	120x120mm frosted glass	
FCD600	Angled yoke	
876	Hook clamp 40x10mm with 28mm M10 screw for Ø35 to 50mm pipes - SWL: 50Kg - Weight: 1,25 Kg	
880	Hook clamp 40x10mm with 28mm M10 screw for Ø50 to 63mm pipes - SWL: 50Kg - Weight: 1,36 Kg	

CS2

Safety cable Ø3 mm L= 600mm - SWL: 75 Kg

